

# SMCJ SERIES

## SURFACE MOUNT TRANSIENT VOLTAGE SUPPRESSOR

### STAND-OFF VOLTAGE - 5.0 TO 440 Volts

### 1500 Watt Peak Pulse Power

#### DO-214AB (SMC J-Bend)

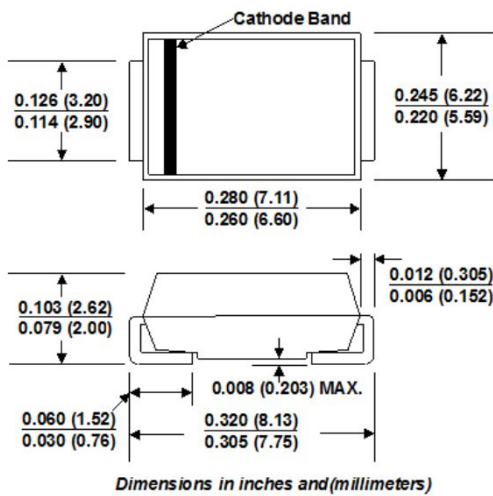

#### FEATURES

- ⊙ For surface mounted applications in order to optimize board space
- ⊙ Halogen-Free
- ⊙ RoHS compliant
- ⊙ Typical maximum temperature coefficient  $\Delta V_{BR}=0.1\% \times V_{BR}@25^{\circ}C \times \Delta T$
- ⊙ Low profile package
- ⊙ Built-in strain relief
- ⊙ Glass passivated junction
- ⊙ Low inductance
- ⊙ Excellent clamping capability
- ⊙ Repetition Rate(duty cycle):0.05%
- ⊙ Fast response time: typically less than 1.0ps from 0 Volts to V(BR)
- ⊙ Typical IR less than 1 $\mu$ A above 12V
- ⊙ High temperature soldering: 260°C/40 seconds at terminals
- ⊙ Plastic package has Underwriters Laboratory Flammability 94V-O
- ⊙ Matte Tin Lead-free plated

#### MECHANICAL DATA

**Case:** JEDEC DO214AB. Molded plastic over glass passivated junction

**Terminal:** Solderable per MIL-STD-750, Method 2026

**Polarity:** Color band denotes positive end (cathode) except Bidirectional

**Standard Packaging:** 16mm tape(EIA STD RS-481)

**Weight:** 0.007ounce, 0.21gram

#### DEVICES FOR BIPOLAR APPLICATION

For Bidirectional use C or CA Suffix for types SMCJ5.0 thru types SMCJ440 (e.g. SMCJ5.0C , SMCJ440CA)  
Electrical characteristics apply in both directions

#### MAXIMUM RATINGS AND CHARACTERISTICS

Ratings at 25°C ambient temperature unless otherwise specified.

RATING	SYMBOL	VALUE	UNITS
Peak Pulse Power Dissipation on 10/1000 $\mu$ s waveform (Note 1,2,FIG.1)	P <sub>PPM</sub>	Minimum 1500	Watts
Peak Pulse Current of on 10/1000 $\mu$ s waveform (Note 1,FIG.3)	I <sub>PPM</sub>	SEE TABLE 1	Amps
Peak Forward Surge Current,8.3ms Single Half Sine-Wave Superimposed on Rated Load,(JEDEC Method) (Note 2,3)	I <sub>FSM</sub>	200	Amps
Operating junction and Storage Temperature Range	T <sub>J</sub> , T <sub>STG</sub>	-55 to + 150	°C

Notes :

1.Non-repetitive current pulse , per Fig. 3 and derated above T<sub>A</sub> = 25°C per Fig. 2 .

2.Mounted on 8.0mm x 8.0mm Copper Pads to each terminal

3.8.3ms single half sine-wave , or equivalent square wave, Duty cycle = 4 pulses per minutes maximum.

# SMCJ SERIES

## SURFACE MOUNT TRANSIENT VOLTAGE SUPPRESSOR

### STAND-OFF VOLTAGE - 5.0 TO 440 Volts

#### 1500 Watt Peak Pulse Power

SMCJ PART NUMBER		DEVICE MARKING CODE		REVERSE STAND- OFF VOLTAGE $V_{RWM}(V)$	BREAKDOWN VOLTAGE $V_{BR}(V) @ I_T$		TEST CURREN T $I_T (mA)$	MAXIMUM CLAMPING VOLTAGE $@ I_{pp} V_C (V)$	PEAK PULSE CURRENT $I_{pp} (A)$	REVERSE LEAKAGE $@ V_{RWM}$ $I_R (\mu A)$
UNI- POLAR	BI-POLAR	UNI	BI		MIN	MAX				
SMCJ5.0A	SMCJ5.0CA	GDE	BDE	5.0	6.40	7.00	10	9.2	163.0	800
SMCJ6.0A	SMCJ6.0CA	GDG	BDG	6.0	6.67	7.37	10	10.3	145.7	800
SMCJ6.5A	SMCJ6.5CA	GDK	BDK	6.5	7.22	7.98	10	11.2	134.0	500
SMCJ7.0A	SMCJ7.0CA	GDM	BDM	7.0	7.78	8.60	10	12.0	125.0	200
SMCJ7.5A	SMCJ7.5CA	GDP	BDP	7.5	8.33	9.21	1	12.9	116.3	100
SMCJ8.0A	SMCJ8.0CA	GDR	BDR	8.0	8.89	9.83	1	13.6	110.3	50
SMCJ8.5A	SMCJ8.5CA	GDT	BDT	8.5	9.44	10.40	1	14.4	104.2	20
SMCJ9.0A	SMCJ9.0CA	GDV	BDV	9.0	10.00	11.10	1	15.4	97.4	10
SMCJ10A	SMCJ10CA	GDX	BDX	10.0	11.10	12.30	1	17.0	88.3	5
SMCJ11A	SMCJ11CA	GDZ	BDZ	11.0	12.20	13.50	1	18.2	82.5	1
SMCJ12A	SMCJ12CA	GEE	BEE	12.0	13.30	14.70	1	19.9	75.4	1
SMCJ13A	SMCJ13CA	GEG	BEG	13.0	14.40	15.90	1	21.5	69.8	1
SMCJ14A	SMCJ14CA	GEK	BEK	14.0	15.60	17.20	1	23.2	64.7	1
SMCJ15A	SMCJ15CA	GEM	BEM	15.0	16.70	18.50	1	24.4	61.5	1
SMCJ16A	SMCJ16CA	GEP	BEP	16.0	17.80	19.70	1	26.0	57.7	1
SMCJ17A	SMCJ17CA	GER	BER	17.0	18.90	20.90	1	27.6	54.4	1
SMCJ18A	SMCJ18CA	GET	BET	18.0	20.00	22.10	1	29.2	51.4	1
SMCJ20A	SMCJ20CA	GEV	BEV	20.0	22.20	24.50	1	32.4	46.3	1
SMCJ22A	SMCJ22CA	GEX	BEX	22.0	24.40	26.90	1	35.5	42.3	1
SMCJ24A	SMCJ24CA	GEZ	BEZ	24.0	26.70	29.50	1	38.9	38.6	1
SMCJ26A	SMCJ26CA	GFE	BFE	26.0	28.90	31.90	1	42.1	35.7	1
SMCJ28A	SMCJ28CA	GFG	BFG	28.0	31.10	34.40	1	45.4	33.1	1
SMCJ30A	SMCJ30CA	GFK	BFK	30.0	33.30	36.80	1	48.4	31.0	1
SMCJ33A	SMCJ33CA	GFM	BFM	33.0	36.70	40.60	1	53.3	28.2	1
SMCJ36A	SMCJ36CA	GFP	BFP	36.0	40.00	44.20	1	58.1	25.9	1
SMCJ40A	SMCJ40CA	GFR	BFR	40.0	44.40	49.10	1	64.5	23.3	1
SMCJ43A	SMCJ43CA	GFT	BFT	43.0	47.80	52.80	1	69.4	21.7	1
SMCJ45A	SMCJ45CA	GFV	BFV	45.0	50.00	55.30	1	72.7	20.6	1
SMCJ48A	SMCJ48CA	GFX	BFX	48.0	53.30	58.90	1	77.4	19.4	1
SMCJ51A	SMCJ51CA	GFZ	BFZ	51.0	56.70	62.70	1	82.4	18.2	1
SMCJ54A	SMCJ54CA	GGE	BGE	54.0	60.00	66.30	1	87.1	17.3	1
SMCJ58A	SMCJ58CA	GGG	BGG	58.0	64.40	71.20	1	93.6	16.1	1
SMCJ60A	SMCJ60CA	GGK	BGK	60.0	66.70	73.70	1	96.8	15.5	1
SMCJ64A	SMCJ64CA	GGM	BGM	64.0	71.10	78.60	1	103.0	14.6	1
SMCJ70A	SMCJ70CA	GGP	BGP	70.0	77.80	86.00	1	113.0	13.3	1
SMCJ75A	SMCJ75CA	GGR	BGR	75.0	83.30	92.10	1	121.0	12.4	1
SMCJ78A	SMCJ78CA	GGT	BGT	78.0	86.70	95.80	1	126.0	11.9	1
SMCJ85A	SMCJ85CA	GGV	BGV	85.0	94.40	104.00	1	137.0	11.0	1
SMCJ90A	SMCJ90CA	GGX	BGX	90.0	100.00	111.00	1	146.0	10.3	1
SMCJ100A	SMCJ100CA	GGZ	BGZ	100.0	111.00	123.00	1	162.0	9.3	1
SMCJ110A	SMCJ110CA	GHE	BHE	110.0	122.00	135.00	1	177.0	8.5	1
SMCJ120A	SMCJ120CA	GHG	BHG	120.0	133.00	147.00	1	193.0	7.8	1
SMCJ130A	SMCJ130CA	GHK	BHK	130.0	144.00	159.00	1	209.0	7.2	1
SMCJ150A	SMCJ150CA	GHM	BHM	150.0	167.00	185.00	1	243.0	6.2	1
SMCJ160A	SMCJ160CA	GHP	BHP	160.0	178.00	197.00	1	259.0	5.8	1
SMCJ170A	SMCJ170CA	GHR	BHR	170.0	189.00	209.00	1	275.0	5.5	1
SMCJ180A	SMCJ180CA	GHT	BHT	180.0	201.00	222.00	1	292.0	5.1	1
SMCJ200A	SMCJ200CA	GHV	BHV	200.0	224.00	247.00	1	324.0	4.6	1
SMCJ220A	SMCJ220CA	GHX	BHX	220.0	246.00	272.00	1	356.0	4.2	1
SMCJ250A	SMCJ250CA	GHZ	BHZ	250.0	279.00	309.00	1	405.0	3.7	1
SMCJ300A	SMCJ300CA	GJE	BJE	300.0	335.00	371.00	1	486.0	3.1	1
SMCJ350A	SMCJ350CA	GJG	BJG	350.0	391.00	432.00	1	567.0	2.6	1
SMCJ400A	SMCJ400CA	GJK	BJK	400.0	447.00	494.00	1	648.0	2.3	1
SMCJ440A	SMCJ440CA	GJM	BJM	440.0	492.00	543.00	1	713.0	2.1	1

For bidirectional type having  $V_{RWM}$  of 10 volts and less, the IR limit is double.

For parts without A , the  $V_{BR}$  is  $\pm 10\%$ ,  $V_C$  is 10% higher than without A Parts.

# SMCJ SERIES

## RATINGS AND CHARACTERISTIC CURVES

### Ratings and Characteristic Curves ( $T_A=25^\circ\text{C}$ unless otherwise noted)

**Fig. 1 - Peak Pulse Power Rating**

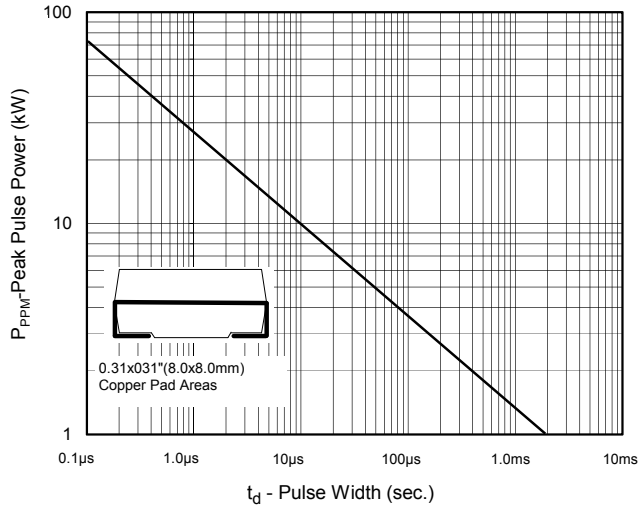

**Fig.2 - Pulse Derating Curve**

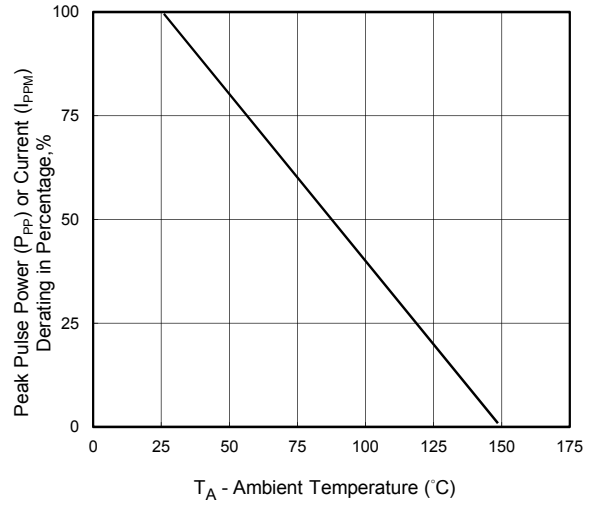

**Fig.3 - Pulse Waveform**

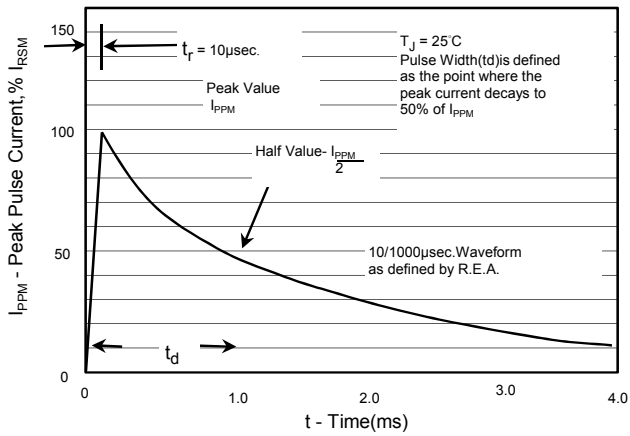

**Fig. 4 - Typical Junction Capacitance**

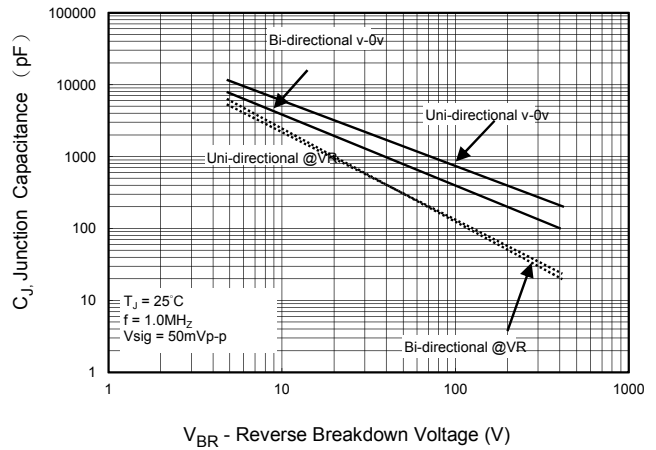

**Fig. 5 - Steady State Power Derating Curve**

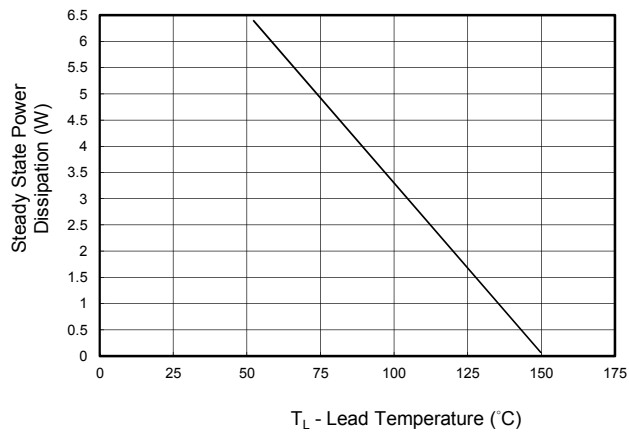

**Fig.6 - Maximum Non-repetitive Forward Surge current uni-directional only**

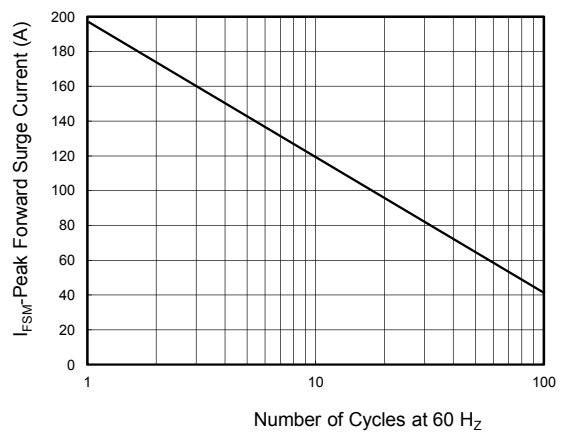

# SMCJ SERIES

## SURFACE MOUNT TRANSIENT VOLTAGE SUPPRESSOR

### Part Numbering System

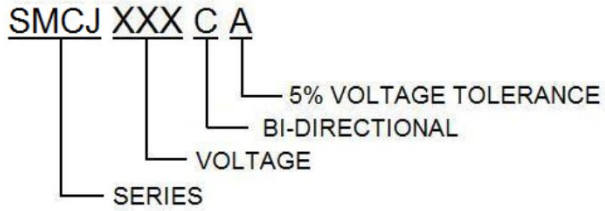

### Part Marking System

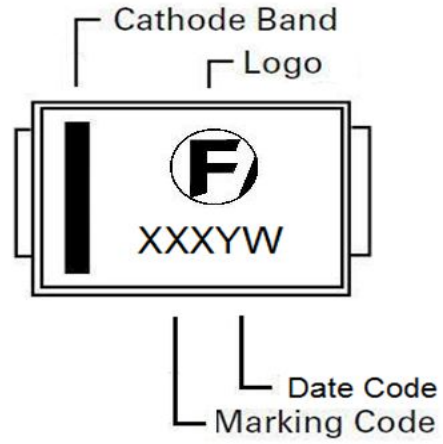

### Packaging

Part number	Component Package	Quantity	Packaging Option	Packaging Specification
SMCJxxxXX	DO-214AB	3000	Tape & Reel - 16mm/13" tape	EIA STD RS-481
SMCJxxxXX	DO-214AB	500	Tape & Reel - 16mm/ 7" tape	EIA STD RS-481